



*Fixed height examination couch*

**326 range**

**326 06T**

**CARINA**  
*Medical*



**CE**  
ISO 9001  
ISO 13485

## TECHNICAL DETAILS

- 3 sections examination couch, width 60cm
- Adjustable backrest and legrest with gas jack
- Upholstery without visible seam with good density 30kg/cm<sup>2</sup>, M1 fire retardant class, thickness 8cm
- Equipped with paper roll holder for exam sheet, on the foot side
- Epoxy covering, light grey colour (RAL 7035) in standard

## DIMENSIONS

- Width 60cm
- Height 80cm
- Load capacity : 130kg

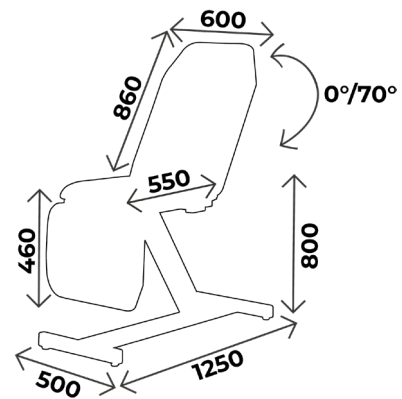

### You may also like :

Ref. **326 06TB** : Same as 326 06T but height 65cm

Ref. **326 07T** : Same as 326 06T but width 70cm

Ref. **326 07TB** : Same as 326 06T but width 70cm and height 65cm



## WHAT YOU NEED TO KNOW

- ✓ Delivery time: 15 days upon receipt of order
- ✓ Warranty : 5 years (1 year for the upholstery)

# ACCESSORIES

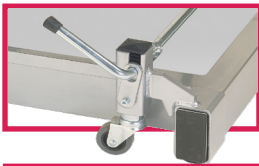

**ACC 999**  
4 retractable wheels diam. 50mm  
for 326 fixed height adjustment  
range



**ACC 990**  
Set of 4 wheels with brake  
diam. 125mm



**ACC 76B**  
Unit clamp to fix infusion stand  
diam. 14mm



**ACC 76**  
Pair of clamps to fix blood test  
splint and stirrups diam. 14mm



**ACC 76C**  
Unit clamp to fix infusion stand  
diam. 16mm



**ACC 32012**  
Stainless steel infusion stand  
diam. 16mm, 2 plastic hooks,  
without clamp

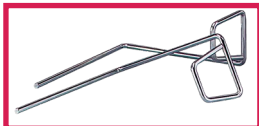

**ACC 105**  
Pair of stainless steel  
stirrups diam. 14mm  
without clamp



**ACC 964**  
Pair of legrests on knee system  
in black polyurethane,  
diam. 14 mm, without clamp



**SLFEMIREPOSE**  
Cover for legrests ACC964  
in upholstery, the unit



**ACC 514-UNIVERSE**  
Plastic protection cover  
for all couches



**ACC 110POLY**  
Polyurethane blood test splint  
without clamp, the unit



**ACC 110**  
Blood test splint in colour  
without clamp, the unit

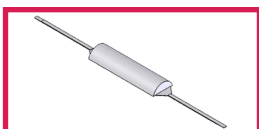

**ACC 32660**  
Half moon headrest width 60cm  
fire retardant M1 class



**ACC TETERGO**  
Ergonomic headrest



**ACC 832**  
Face hole with plug cushion



**ACC BARRILIT326B**  
Pair of retractable security side  
rails for 326, 3 sections

# UPHOLSTERY'S COLOURS

Fire retardant  
upholstery, M1 class

For the upholstery colours, you can choose between the Classic and Urban range  
Be careful ! Urban colours **with extra value**

## *Upholstery : Classic range*



Arno



Garonne



Potomac

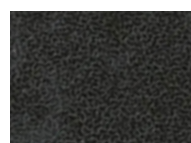

Amour

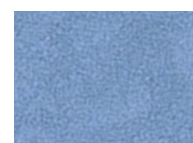

Mississippi



St Laurent



Rhône



Missouri



Seine

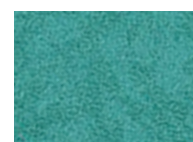

Amazone

## *Upholstery : Urban range*



Abysses

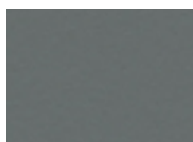

Cendre



Origan

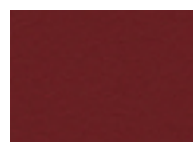

Géranium



Réglisse



Prune

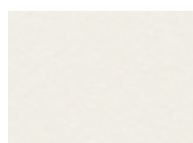

Perle

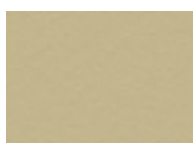

Ficelle

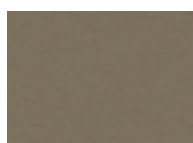

Terre

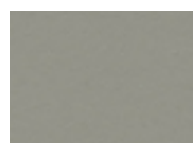

Béton

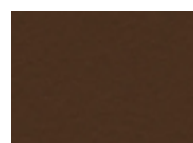

Chataigne

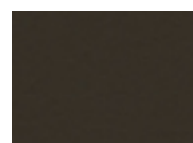

Chocolat



Pensée



Pétrole



Turquoise



Granny



Absinthe



Ananas



Orange



Fuschia



Tomate

# BASE COLOURS

The entire 326 range is offered in light grey (RAL 7035) as standard  
Possibility to change the color without extra charge

## *Base colour*

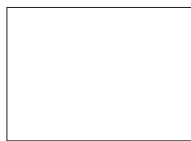

**RAL 9003**

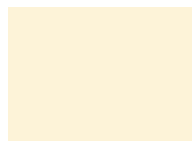

**RAL 1013**

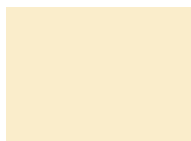

**RAL 1015**

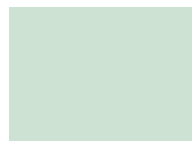

**RAL 6019**



**RAL 6033**



**RAL 6000**



**RAL 5017**



**RAL 5002**



**RAL 5000**

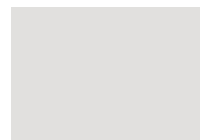

**RAL 7035**



**RAL 7016**

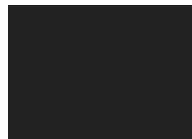

**RAL 9005**



**RAL 1018**



**RAL 3020**



**RAL 3003**

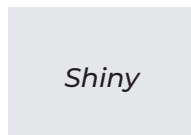

*Shiny*

**SILVER**



# MAINTENANCE GUIDE

## **DAILY MAINTENANCE**

Upholstery : Cleaning with soapy water only (no solvents), can be disinfected with products such as Phagosept Spray, Salvanios pH10 at 0.75% and Anios Surfaces Hautes, without abrasive material

Base : cleaning with soapy water only (no solvents) without abrasive materials

## **WARRANTY**

Mechanical/ electrical part : 5 years

Upholstery : 1 year



**CONTACT**

**CARINA**  
*Médical*

Parc d'entreprises Visionis  
278 rue de l'industrie  
01090 GUÉREINS- FRANCE

**COMMERCIAL DEPARTMENT**

Tél : +33(0)4 74 66 69 49  
Fax : +33(0)4 74 66 69 50  
[export@carinamedical.com](mailto:export@carinamedical.com)